



Digital Output Temperature Sensor with On-board SPD EEPROM



FEATURES

- JEDEC JC42.4 Compliant Temperature Sensor
- Temperature Range: - 40°C to +125°C
- DDR3 DIMM compliant SPD EEPROM
- Supply Range: 3.3 V ± 10%
- I²C / SMBus Interface
- Schmitt Triggers and Noise Suppression Filters on SCL and SDA Inputs
- Low Power CMOS Technology
- RoHS-compliant 2 x 3 x 0.75 mm TDFN package

For Ordering Information details, see page 21.

PIN CONFIGURATION

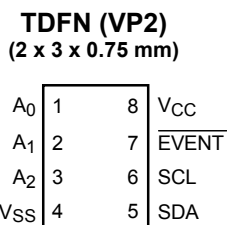

Note: For the location of Pin 1, please consult the corresponding package drawing.

PIN FUNCTIONS

Name	Description
A ₀ , A ₁ , A ₂	Device Address Input
SDA	Serial Data Input/Output
SCL	Serial Clock Input
$\overline{\text{EVENT}}$	Open-drain Event Output
V _{CC}	Power Supply
V _{SS}	Ground
DAP	Backside exposed DAP at V _{SS}

DESCRIPTION

The CAT34TS02 combines a JC42.4 compliant Temperature Sensor (TS) with 2-Kb of Serial Presence Detect (SPD) EEPROM.

The TS measures temperature at least 10 times every second. Temperature readings can be retrieved by the host via the serial interface, and are compared to high, low and critical trigger limits stored into internal registers. Over or under limit conditions can be signaled on the open-drain $\overline{\text{EVENT}}$ pin.

The integrated 2-Kb SPD EEPROM is internally organized as 16 pages of 16 bytes each, for a total of 256 bytes. It features a 16-byte page write buffer and supports both the Standard (100 kHz) as well as Fast (400 kHz) I²C protocol.

Write operations to the lower half memory can be inhibited via software commands. The CAT34TS02 features Permanent, as well as Reversible Software Write Protection, as defined for DDR3 DIMMs.

FUNCTIONAL SYMBOL

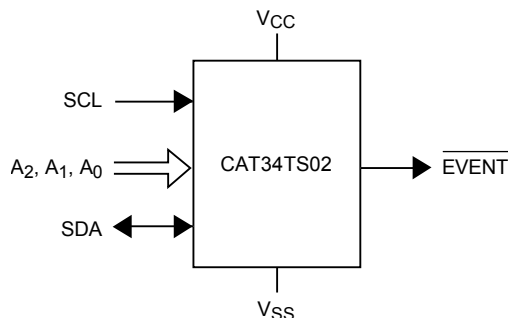

CAT34TS02

ABSOLUTE MAXIMUM RATINGS⁽¹⁾

Parameter	Rating	Units
Operating Temperature	-45 to +130	°C
Storage Temperature	-65 to +150	°C
Voltage on any pin (except A ₀) with respect to Ground ⁽²⁾	-0.5 to +6.5	V
Voltage on pin A ₀ with respect to Ground	-0.5 to +10.5	V

RELIABILITY CHARACTERISTICS⁽³⁾

Symbol	Parameter	Min	Units
N _{END} ⁽⁴⁾	Endurance (EEPROM)	1,000,000	Write Cycles
T _{DR}	Data Retention (EEPROM)	100	Years

TEMPERATURE CHARACTERISTICS

V_{CC} = 3.3 V ± 10%, T_A = -40°C to +125°C, unless otherwise specified

Parameter	Test Conditions/Comments	Max	Unit
Temperature Reading Error Class B, JC42.4 compliant	+75°C ≤ T _A ≤ +95°C, active range	±1.0	°C
	+40°C ≤ T _A ≤ +125°C, monitor range	±2.0	°C
	-40°C ≤ T _A ≤ +125°C, sensing range	±3.0	°C
ADC Resolution		12	Bits
Temperature Resolution		0.0625	°C
Conversion Time		100	ms
Thermal Resistance ⁽³⁾ θ _{JA}	Junction-to-Ambient (Still Air)	92	°C/W

D.C. OPERATING CHARACTERISTICS

V_{CC} = 3.3 V ± 10%, T_A = -40°C to +125°C, unless otherwise specified

Symbol	Parameter	Test Conditions/Comments	Min	Max	Unit
I _{CC}	Supply Current	TS active, SPD and Bus idle		500	μA
		EEPROM Write, TS shut-down		500	μA
I _{SHDN}	Standby Current	TS shut-down; SPD and Bus idle		5	μA
I _{LKG}	I/O Pin Leakage Current	Pin at GND or V _{CC}		5	μA
V _{IL}	Input Low Voltage		-0.5	0.3 × V _{CC}	V
V _{IH}	Input High Voltage		0.7 × V _{CC}	V _{CC} + 0.5	V
V _{OL1}	Output Low Voltage	I _{OL} = 3 mA, V _{CC} > 2.7 V		0.4	V
V _{OL2}	Output Low Voltage	I _{OL} = 1 mA, V _{CC} < 2.7 V		0.2	V

Notes:

- (1) Stresses above those listed under "Absolute Maximum Ratings" may cause permanent damage to the device. These are stress ratings only, and functional operation of the device at these or any other conditions outside of those listed in the operational sections of this specification is not implied. Exposure to any absolute maximum rating for extended periods may affect device performance and reliability.
- (2) The DC input voltage on any pin should not be lower than -0.5 V or higher than V_{CC} + 0.5 V. The A₀ pin can be raised to a HV level for RSWP command execution. SCL and SDA inputs can be raised to the maximum limit, irrespective of V_{CC}.
- (3) Power Dissipation is defined as P_J = (T_J - T_A)/θ_{JA}, where T_J is the junction temperature and T_A is the ambient temperature. The thermal resistance value refers to the case of a package being used on a standard 2-layer PCB.
- (4) Page Mode, V_{CC} = 3.3 V, 25°C

A.C. CHARACTERISTICS⁽¹⁾
 $V_{CC} = 3.3 \text{ V} \pm 10\%$, $T_A = -40^\circ\text{C}$ to $+125^\circ\text{C}$

Symbol	Parameter	Min	Max	Units
$F_{SCL}^{(2)}$	Clock Frequency	10	400	kHz
t_{HIGH}	High Period of SCL Clock	600		ns
t_{LOW}	Low Period of SCL Clock	1300		ns
$t_{TIMEOUT}^{(2)}$	SMBus SCL Clock Low Timeout	25	35	ms
$t_R^{(3)}$	SDA and SCL Rise Time		300	ns
$t_F^{(3)}$	SDA and SCL Fall Time		300	ns
$t_{SU:DAT}^{(4)}$	Data Setup Time	100		ns
$t_{HD:DAT}^{(3)}$	Data Hold Time (for Input Data)	0		ns
	Data Hold Time (for Output Data)	300	900	ns
$t_{SU:STA}$	START Condition Setup Time	600		ns
$t_{HD:STA}$	START Condition Hold Time	600		ns
$t_{SU:STO}$	STOP Condition Setup Time	600		ns
t_{BUF}	Bus Free Time Between STOP and START	1300		ns
T_i	Noise Pulse Filtered at SCL and SDA Inputs		100	ns
t_{WR}	Write Cycle Time		5	ms
$t_{PU}^{(5)}$	Power-up Delay to Valid Temperature Recording		100	ms

PIN CAPACITANCE
 $T_A = 25^\circ\text{C}$, $V_{CC} = 3.3 \text{ V}$, $f = 1 \text{ MHz}$

Symbol	Parameter	Test Conditions/Comments	Min	Max	Unit
C_{IN}	SDA, $\overline{\text{EVENT}}$ Pin Capacitance	$V_{IN} = 0$		8	pF
	Input Capacitance (other pins)	$V_{IN} = 0$		6	pF

Notes:

- (1) Timing reference points are set at 30%, respectively 70% of V_{CC} , as illustrated in Figure 4. Bus loading must be such as to allow meeting the V_{IL} , V_{OL} as well as the various timing limits.
- (2) The TS interface will reset itself and will release the SDA line if the SCL line stays low beyond the $t_{TIMEOUT}$ limit. The time-out count is started (and then re-started) on every negative transition of SCL in the time interval between START and STOP. The minimum clock frequency of 10 kHz is an SMBus recommendation; the minimum operating clock frequency for the CAT34TS02's SPD component is DC, while the minimum operating frequency for the TS component is limited only by the SMBus time-out.
- (3) In a "Wired-OR" system (such as I²C or SMBus), SDA rise time is determined by bus loading. Since each bus pull-down device must be able to sink the (external) bus pull-up current (in order to meet the V_{IL} and/or V_{OL} limits), it follows that SDA fall time is inherently faster than SDA rise time. SDA rise time can exceed the standard recommended t_R limit, as long as it does not exceed $t_{LOW} - t_{HD:DAT} - t_{SU:DAT}$, where t_{LOW} and $t_{HD:DAT}$ are actual values (rather than spec limits). A shorter $t_{HD:DAT}$ leaves more room for a longer SDA t_R , allowing for a more capacitive bus or a larger bus pull-up resistor. At the minimum t_{LOW} spec limit of 1300 ns, the maximum $t_{HD:DAT}$ of 900 ns demands a maximum SDA t_R of 300 ns. The CAT34TS02's maximum $t_{HD:DAT}$ is <700 ns, thus allowing for an SDA t_R of up to 500 ns at minimum t_{LOW} .
- (4) The minimum $t_{SU:DAT}$ of 100 ns is a limit recommended by standards. The CAT34TS02 will accept a $t_{SU:DAT}$ of 0 ns.
- (5) The first valid temperature recording can be expected after t_{PU} at nominal supply voltage.

TYPICAL PERFORMANCE CHARACTERISTICS

$V_{CC} = 3.3\text{ V}$, $T_A = -25^{\circ}\text{C}$ to $+125^{\circ}\text{C}$, unless otherwise specified.

TS Active Current
(I²C-bus and SPD EEPROM idle)

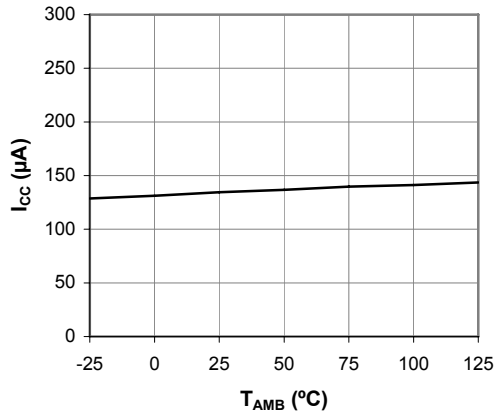

Standby Current
(I²C-bus and SPD EEPROM idle, TS shut-down)

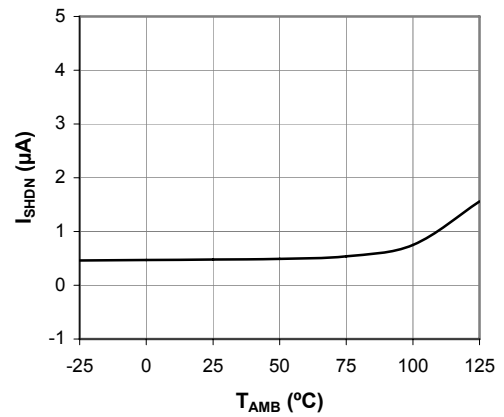

SPD EEPROM Write Current
(I²C-bus idle, TS shut-down)

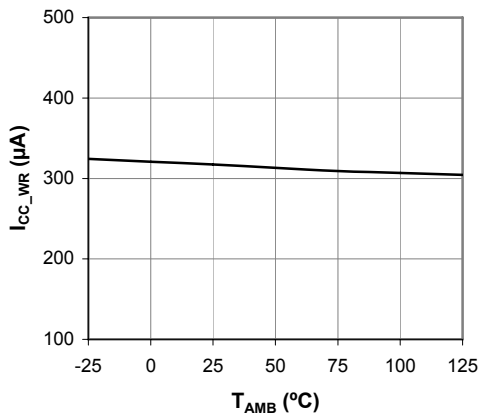

Temperature Read-Out Error

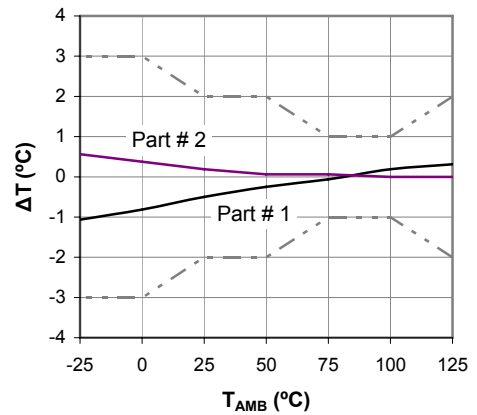

A/D Conversion Time

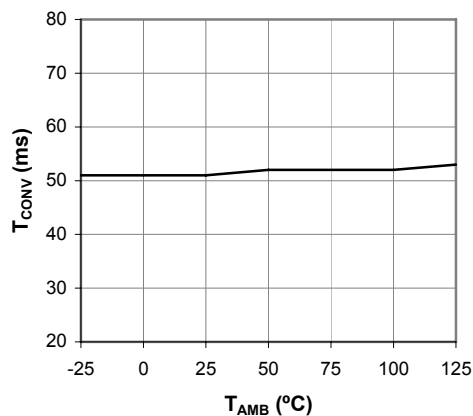

EEPROM Write Time

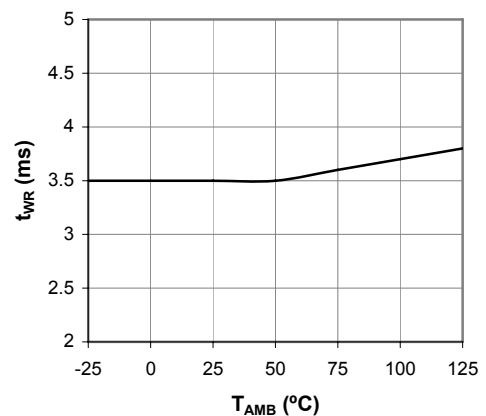

TYPICAL PERFORMANCE CHARACTERISTICS

$V_{CC} = 3.3\text{ V}$, $T_A = -25^\circ\text{C}$ to $+125^\circ\text{C}$, unless otherwise specified.

TS POR Threshold Voltage

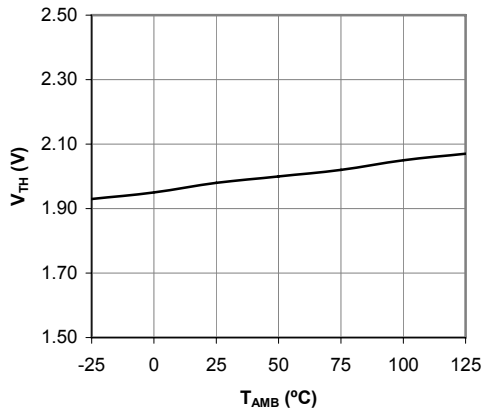

SPD POR Threshold Voltage

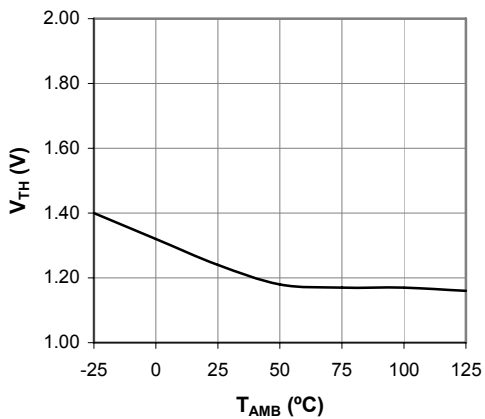

SMBus SCL Clock Low Timeout

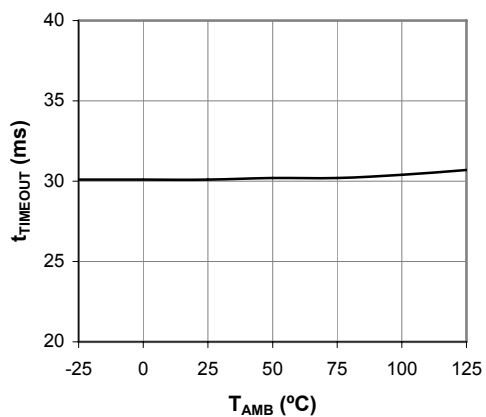

PIN DESCRIPTION

SCL: The Serial Clock input pin accepts the Serial Clock generated by the Master (Host).

SDA: The Serial Data I/O pin receives input data and transmits data stored in the internal registers. In transmit mode, this pin is open drain. Data is acquired on the positive edge, and is delivered on the negative edge of SCL.

A0, A1 and A2: The Address pins accept the device address. These pins have on-chip pull-down resistors.

EVENT: The open-drain $\overline{\text{EVENT}}$ pin can be programmed to signal over/under temperature limit conditions.

POWER-ON RESET (POR)

The CAT34TS02 incorporates Power-On Reset (POR) circuitry which protects the device against powering up to invalid state. The CAT34TS02 will power up into TS conversion mode and EEPROM standby mode after V_{CC} exceeds the POR trigger level and will power down into Reset mode when V_{CC} drops below the POR trigger level. This bi-directional feature protects the device against brown-out failure following a temporary loss of power. The POR trigger levels for the TS and EEPROM component are set below the respective minimum operating V_{CC} levels.

DEVICE INTERFACE

The CAT34TS02 supports the Inter-Integrated Circuit (I^2C) and the System Management Bus (SMBus) data transmission protocols. These protocols describe serial communication between transmitters and receivers sharing a 2-wire data bus. Data flow is controlled by a Master device, which generates the serial clock and the START and STOP conditions. The CAT34TS02 acts as a Slave device. Master and Slave alternate as transmitter and receiver. Up to 8 CAT34TS02 devices may be present on the bus simultaneously, and can be individually addressed by matching the logic state of the address inputs A0, A1, and A2.

I^2C /SMBus PROTOCOL

The I^2C /SMBus uses two 'wires', one for clock (SCL) and one for data (SDA). The two wires are connected to the V_{CC} supply via pull-up resistors. Master and Slave devices connect to the bus via their respective SCL and SDA pins. The transmitting device pulls down the SDA line to 'transmit' a '0' and releases it to 'transmit' a '1'.

Data transfer may be initiated only when the bus is not busy (see A.C. Characteristics).

During data transfer, the SDA line must remain stable while the SCL line is HIGH. An SDA transition while SCL is HIGH will be interpreted as a START or STOP condition (Figure 1).

START

The START condition precedes all commands. It consists of a HIGH to LOW transition on SDA while SCL is HIGH. The START acts as a 'wake-up' call to all Slaves. Absent a START, a Slave will not respond to commands.

STOP

The STOP condition completes all commands. It consists of a LOW to HIGH transition on SDA while SCL is HIGH. The STOP tells the Slave that no more data will be written to or read from the Slave.

DEVICE ADDRESSING

The Master initiates data transfer by creating a START condition on the bus. The Master then broadcasts an 8-bit serial Slave address. The first 4 bits of the Slave address (the preamble) select either the Temperature Sensor (TS) registers (0011) or the EEPROM memory contents (1010), as shown in Figure 2. The next 3 bits, A2, A1 and A0, select one of 8 possible Slave devices. The last bit, R/W, specifies whether a Read (1) or Write (0) operation is being performed.

ACKNOWLEDGE

A matching Slave address is acknowledged (ACK) by the Slave by pulling down the SDA line during the 9th clock cycle (Figure 3). After that, the Slave will acknowledge all data bytes sent to the bus by the Master. When the Slave is the transmitter, the Master will in turn acknowledge data bytes in the 9th clock cycle. The Slave will stop transmitting after the Master does not respond with acknowledge (NoACK) and then issues a STOP. Bus timing is illustrated in Figure 4.

Figure 1. Start/Stop Timing

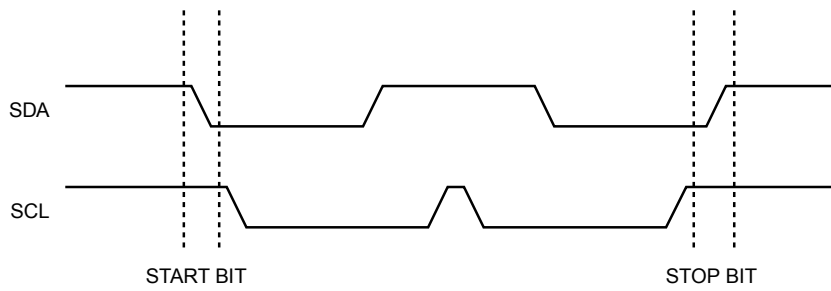

Figure 2. Slave Address Bits

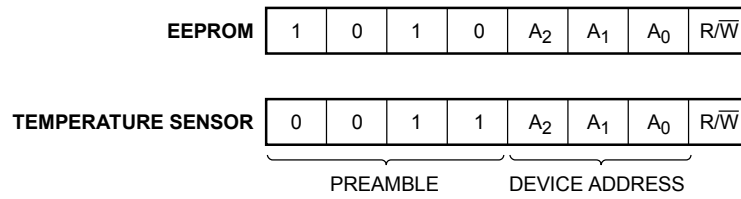

Figure 3. Acknowledge Timing

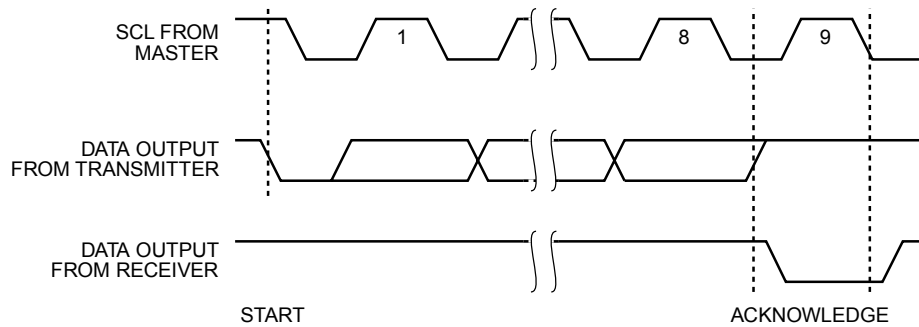
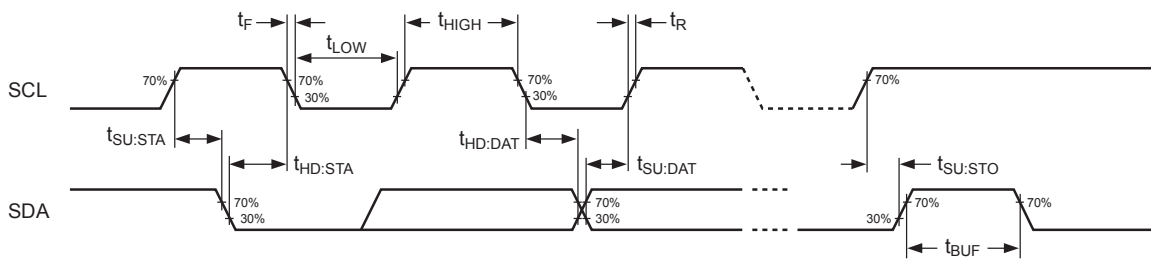

Figure 4. Bus Timing



WRITE OPERATIONS

EEPROM Byte and TS Register Write

To write data to a TS register, or to the on-board EEPROM, the Master creates a START condition on the bus, and then sends out the appropriate Slave address (with the R/\overline{W} bit set to '0'), followed by an address byte and data byte(s). The matching Slave will acknowledge the Slave address, EEPROM byte or TS register address and the data byte(s), one for EEPROM data (Figure 5) and two for TS register data (Figure 6). The Master then ends the session by creating a STOP condition on the bus. The STOP completes the (volatile) TS register update or starts the internal Write cycle for the (non-volatile) EEPROM data (Figure 7).

EEPROM Page Write

The on-board EEPROM contains 256 bytes of data, arranged in 16 pages of 16 bytes each. A page is selected by the 4 most significant bits of the address byte immediately following the Slave address, while the 4 least significant bits point to the byte within the page. Up to 16 bytes can be written in one Write cycle (Figure 8).

The internal EEPROM byte address counter is automatically incremented after each data byte is loaded. If the Master transmits more than 16 data bytes, then earlier data will be overwritten by later data in a 'wrap-around' fashion within the selected page. The internal Write cycle, using the most recently loaded data, then starts immediately following the STOP.

Acknowledge Polling

Acknowledge polling can be used to determine if the CAT34TS02 is busy writing to EEPROM, or is ready to accept commands. Polling is executed by interrogating the device with a 'Selective Read' command (see READ OPERATIONS). The CAT34TS02 will not acknowledge the Slave address as long as internal EEPROM Write is in progress.

DELIVERY STATE

The CAT34TS02 is shipped 'unprotected', i.e. neither Software Write Protection (SWP) flag is set. The entire 2-Kb memory is erased, i.e. all bytes are 0xFF.

Figure 5. EEPROM Byte Write

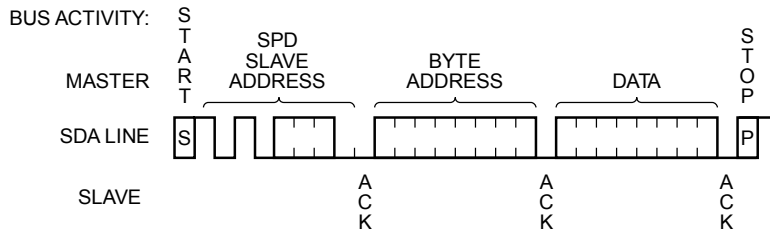

Figure 6. Temperature Sensor Register Write

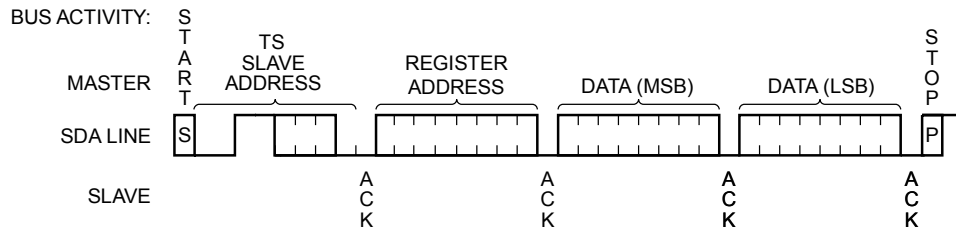

Figure 7. EEPROM Write Cycle Timing

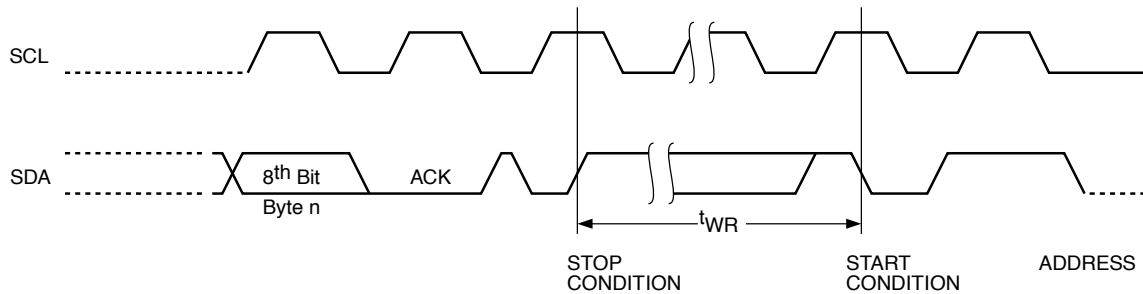
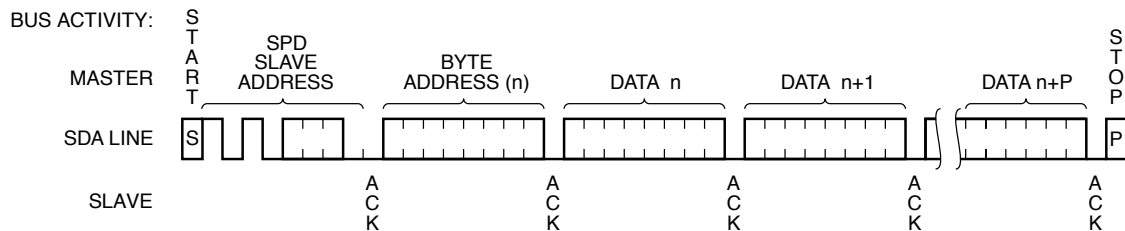

Figure 8. EEPROM Page Write



NOTE: IN THIS EXAMPLE $n = \text{XXXX } 0000(\text{B})$; $X = 1 \text{ or } 0$

READ OPERATIONS

Immediate Read

Upon power-up, the address counters for both the Temperature Sensor (TS) and on-board EEPROM are initialized to 00h. The TS address counter will thus point to the Capability Register and the EEPROM address counter will point to the first location in memory. The two address counters may be updated by subsequent operations.

A CAT34TS02 presented with a Slave address containing a '1' in the $\overline{R/W}$ position will acknowledge the Slave address and will then start transmitting data being pointed at by the current EEPROM data or respectively TS register address counter. The Master stops this transmission by responding with NoACK, followed by a STOP (Figure 9).

Selective Read

The Read operation can be started at an address different from the one stored in the respective address counters, by preceding the Immediate Read sequence with a 'data less' Write operation. The Master sends out a START, Slave address and address byte, but rather than following up with data (as in a Write operation), the Master then issues another START and continues with an Immediate Read sequence (Figure 10).

Sequential EEPROM Read

EEPROM data can be read out indefinitely, as long as the Master responds with ACK (Figure 11). The internal address count is automatically incremented after every data byte sent to the bus. If the end of memory is reached during continuous Read, then the address counter 'wraps-around' to beginning of memory, etc. Sequential Read works with either Immediate Read or Selective Read, the only difference being that in the latter case the starting address is intentionally updated.

Figure 9. Immediate Read

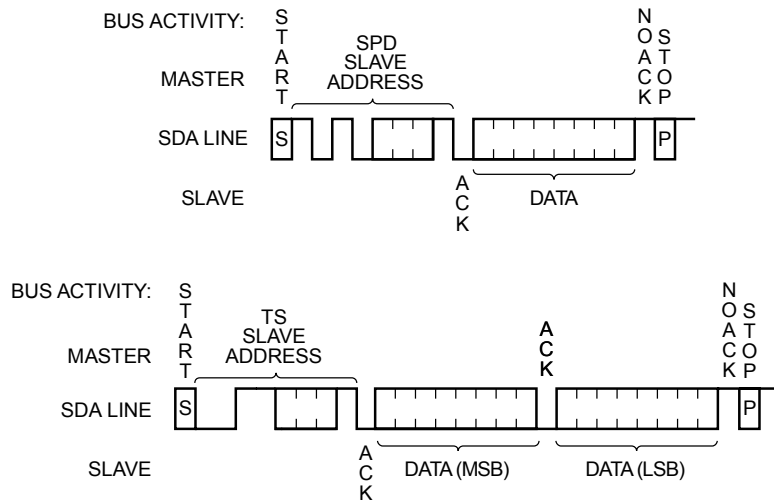

Figure 10. Selective Read

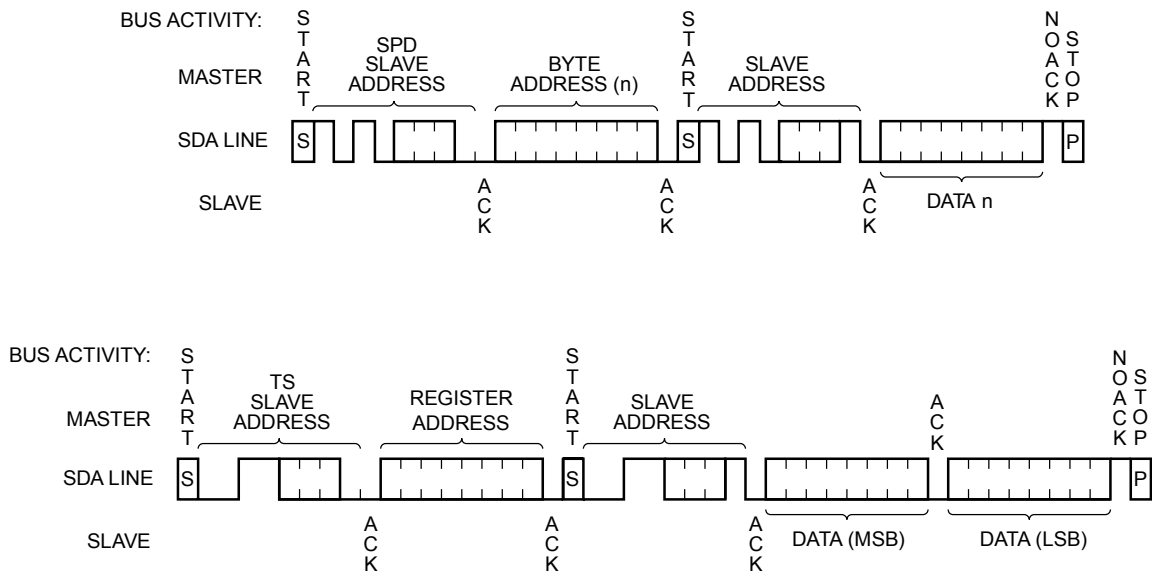
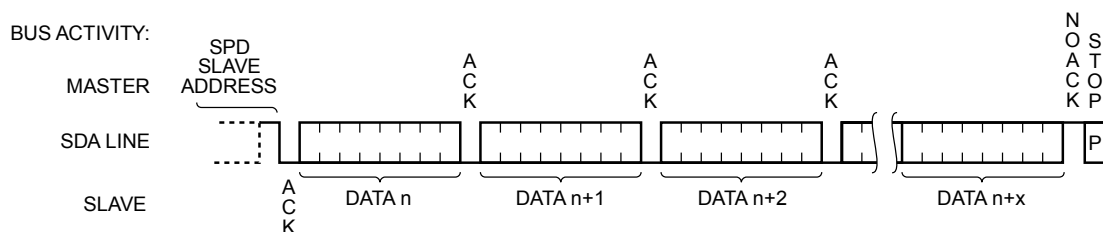

Figure 11. EEPROM Sequential Read



SOFTWARE WRITE PROTECTION

The lower half of memory (first 128 bytes) can be protected against Write requests by setting one of two Software Write Protection (SWP) flags.

The Permanent Software Write Protection (PSWP) flag can be set or read while all address pins are at regular CMOS levels (GND or V_{CC}), whereas the very high voltage V_{HV} must be present on address pin A0 to set, clear or read the Reversible Software Write Protection (**RSWP**) flag. The D.C. OPERATING CONDITIONS for RSWP operations are shown in Table 1.

The SWP commands are listed in Table 2. All commands are preceded by a START and terminated with a STOP, following the ACK or NoACK from the CAT34TS02. All SWP related Slave addresses use the pre-amble: 0110 (6h), instead of the regular 1010 (Ah) used for memory access. For **PSWP** commands, the three address pins can be at any logic level, whereas for **RSWP** commands the address pins must be at pre-assigned logic levels.

V_{HV} is interpreted as logic '1'. The V_{HV} condition must be established on pin A0 before the START and maintained just beyond the STOP. Otherwise an RSWP request could be interpreted by the CAT34TS02 as a PSWP request.

The SWP Slave addresses follow the standard I²C convention, i.e. to read the state of the SWP flag, the LSB of the Slave address must be '1', and to set or clear a flag, it must be '0'. For Write commands a dummy byte address and dummy data byte must be provided (Figure 12). In contrast to a regular memory Read, a SWP Read does not return Data. Instead the CAT34TS02 will respond with NoACK if the flag is set and with ACK if the flag is not set. Therefore, the Master can immediately follow up with a STOP, as there is no meaningful data following the ACK interval (Figure 13).

Table 1: RSWP D.C. Operation Condition

Symbol	Parameter	Test Conditions	Min	Max	Units
ΔV_{HV}	A ₀ Overdrive ($V_{HV} - V_{CC}$)	1.7 V < V_{CC} < 3.6 V	4.8		V
I_{HVD}	A ₀ High Voltage Detector Current			0.1	mA
V_{HV}	A ₀ Very High Voltage		7	10	V

Table 2. SWP Commands

Action	Control Pin Levels ⁽¹⁾			Flag State ⁽²⁾		Slave Address					ACK ?	Address Byte	ACK ?	Data Byte	ACK ?	Write Cycle
	A ₂	A ₁	A ₀	PSWP	RSWP	b7 to b4	b3	b2	b1	b0						
Set PSWP	A ₂	A ₁	A ₀	1	X	0110	A ₂	A ₁	A ₀	X	No					
	A ₂	A ₁	A ₀	0	X		A ₂	A ₁	A ₀	0	Yes	X	Yes	X	Yes	Yes
	A ₂	A ₁	A ₀	0	X		A ₂	A ₁	A ₀	1	Yes					
Set RSWP	GND	GND	V _{HV}	1	X		0	0	1	X	No					
	GND	GND	V _{HV}	0	1		0	0	1	X	No					
	GND	GND	V _{HV}	0	0		0	0	1	0	Yes	X	Yes	X	Yes	Yes
	GND	GND	V _{HV}	0	0		0	0	1	1	Yes					
Clear RSWP	GND	V _{CC}	V _{HV}	1	X		0	1	1	X	No					
	GND	V _{CC}	V _{HV}	0	X		0	1	1	0	Yes	X	Yes	X	Yes	Yes
	GND	V _{CC}	V _{HV}	0	X	0	1	1	1	Yes						

Figure 12. Software Write Protect (Write)

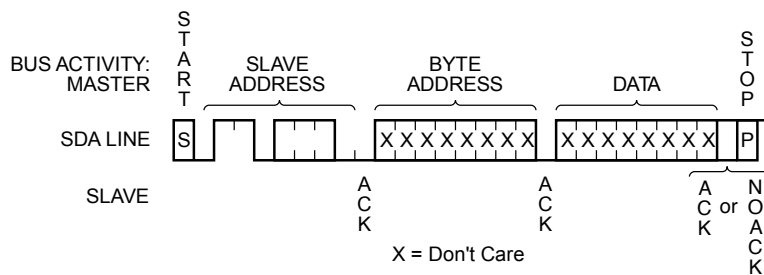
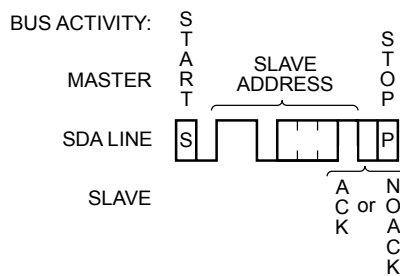

Figure 13. Software Write Protect (Read)



Notes:

- (1) Here A₂, A₁ and A₀ are either at V_{CC} or GND.
- (2) 1 stands for 'Set', 0 stands for 'Not Set', X stands for 'don't care'.

TEMPERATURE SENSOR OPERATION

The TS component in the CAT34TS02 combines a Proportional to Absolute Temperature (PTAT) sensor with a Σ - Δ modulator, yielding a 12 bit plus sign digital temperature representation.

The TS runs on an internal clock, and starts a new conversion cycle at least every 100 ms. The result of the most recent conversion is stored in the **Temperature Data Register (TDR)**, and remains there following a TS Shut-Down. Reading from the **TDR** does not interfere with the conversion cycle.

The value stored in the **TDR** is compared against limits stored in the **High Limit Register (HLR)**, the **Low Limit Register (LLR)** and/or **Critical Temperature Register (CTR)**. If the measured value is outside the alarm limits or above the critical limit, then the $\overline{\text{EVENT}}$ pin may be asserted. The $\overline{\text{EVENT}}$ output function is programmable, via the **Configuration Register** for interrupt mode, comparator mode and polarity.

The temperature limit registers can be Read or Written by the host, via the serial interface. At power-on, all the (writable) internal registers default to 0x0000, and should therefore be initialized by the host to the desired values. The $\overline{\text{EVENT}}$ output starts out disabled (corresponding to polarity active low); thus preventing irrelevant event bus activity before the limit registers are initialized. While the TS is enabled (not shut-down), event conditions are normally generated by a change in measured temperature as recorded in the TDR, but limit changes can also trigger events as soon as the new limit creates an event condition, i.e. asynchronously with the temperature sampling activity.

In order to minimize the thermal resistance between sensor and PCB, it is recommended that the exposed backside die attach pad (DAP) be soldered to the PCB ground plane.

REGISTERS

The CAT34TS02 contains eight 16-bit wide registers allocated to TS functions, as shown in Table 3. Upon power-up, the internal address counter points to the capability register.

Capability Register (User Read Only)

This register lists the capabilities of the TS, as detailed in the corresponding bit map.

Configuration Register (Read/Write)

This register controls the various operating modes of the TS, as detailed in the corresponding bit map.

Temperature Trip Point Registers (Read/Write)

The CAT34TS02 features 3 temperature limit registers, the **HLR**, **LLR** and **CLR** mentioned earlier. The temperature value recorded in the **TDR** is compared to the various limit values, and the result is used to activate the $\overline{\text{EVENT}}$ pin. To avoid undesirable $\overline{\text{EVENT}}$ pin activity, this pin is automatically disabled at power-up to allow the host to initialize the limit registers and the converter to complete the first conversion cycle under nominal supply conditions. Data format is two's complement with the LSB representing 0.25°C, as detailed in the corresponding bit maps.

Temperature Data Register (User Read Only)

This register stores the measured temperature, as well as trip status information. B15, B14, and B13 are the trip status bits, representing the relationship between measured temperature and the 3 limit values; these bits are not affected by $\overline{\text{EVENT}}$ status or by Configuration register settings. Measured temperature is represented by bits B12 to B0. Data format is two's complement, where B12 represents the sign, B11 represents 128°C, etc. and B0 represents 0.0625°C.

Manufacturer ID Register (Read Only)

The manufacturer ID assigned by the PCI-SIG trade organization to the CAT34TS02 device is fixed at 0x1B09.

Device ID and Revision Register (Read Only)

This register contains manufacturer specific device ID and device revision information.

Table 3: The TS Registers

Register Address	Register Name	Power-On Default	Read/Write
0x00	Capability Register	0x005F	Read
0x01	Configuration Register	0x0000	Read/Write
0x02	High Limit Register	0x0000	Read/Write
0x03	Low Limit Register	0x0000	Read/Write
0x04	Critical Limit Register	0x0000	Read/Write
0x05	Temperature Data Register	Undefined	Read
0x06	Manufacturer ID Register	0x1B09	Read
0x07	Device ID/Revision Register	0x0812	Read

CAPABILITY REGISTER

B15	B14	B13	B12	B11	B10	B9	B8
RFU	RFU	RFU	RFU	RFU	RFU	RFU	RFU
B7	B6	B5	B4	B3	B2	B1	B0
EVSD	TMOUT	RFU	TRES [1:0]		RANGE	ACC	EVENT

Bit	Description
B15:B8, B5	Reserved for future use; can not be written; should be ignored; will read as 0
B7 ⁽¹⁾	0: Configuration Register bit 4 is frozen upon Configuration Register bit 8 being set (i.e. a TS shut-down freezes the <u>EVENT</u> output) 1: Configuration Register bit 4 is cleared upon Configuration Register bit 8 being set (i.e. a TS shut-down de-asserts the <u>EVENT</u> output)
B6	0: The TS implements SMBus time-out within the range 10 to 60 ms 1: The TS implements SMBus time-out within the range 25 to 35 ms
B4:B3	00: LSB = 0.50°C (9 bit resolution) 01: LSB = 0.25°C (10 bit) 10: LSB = 0.125°C (11 bit) 11: LSB = 0.0625°C (12 bit)
B2	0: Positive Temperature Only 1: Positive and Negative Temperature
B1	0: ±2°C over the active range and ±3°C over the operating range (Class C) 1: ±1°C over the active range and ±2°C over the monitor range (Class B)
B0	0: Critical Temperature only 1: Alarm and Critical Temperature

Notes:

- (1) Configuration Register bit 4 can be cleared (but not set) after Configuration Register bit 8 is set, by writing a "1" to Configuration Register bit 5 (EVENT output can be de-asserted during TS shut-down periods)

CONFIGURATION REGISTER

B15	B14	B13	B12	B11	B10	B9	B8
RFU	RFU	RFU	RFU	RFU	HYST [1:0]		SHDN
B7	B6	B5	B4	B3	B2	B1	B0
TCRIT_LOCK	EVENT_LOCK	CLEAR	EVENT_STS	EVENT_CTRL	TCRIT_ONLY	EVENT_POL	EVENT_MODE

Bit	Description
B15:B11	Reserved for future use ; can not be written ; should be ignored; will read as 0
B10:B9⁽¹⁾	00: Disable hysteresis 01: Set hysteresis at 1.5°C 10: Set hysteresis at 3°C 11: Set hysteresis at 6°C
B8⁽⁵⁾	0: Thermal Sensor is enabled; temperature readings are updated at sampling rate 1: Thermal Sensor is shut down; temperature reading is frozen to value recorded before SHDN
B7⁽⁴⁾	0: Critical trip register can be updated 1: Critical trip register cannot be modified; this bit can be cleared only at POR
B6⁽⁴⁾	0: Alarm trip registers can be updated 1: Alarm trip registers cannot be modified; this bit can be cleared only at POR
B5⁽³⁾	0: Always reads as 0 (self-clearing) 1: Writing a 1 to this position clears an event recording in interrupt mode only
B4⁽²⁾	0: EVENT output pin is not being asserted 1: EVENT output pin is being asserted
B3⁽¹⁾	0: EVENT output disabled; <i>polarity dependent</i> : open-drain for B1 = 0; grounded for B1 = 1 1: EVENT output enabled
B2⁽⁷⁾	0: event condition triggered by alarm or critical temperature limit crossing 1: event condition triggered by critical temperature limit crossing only
B1^{(1), (6)}	0: EVENT output active low 1: EVENT output active high
B0⁽¹⁾	0: Comparator mode 1: Interrupt mode

Notes:

- (1) Can not be altered (set or cleared) as long as either one of the two lock bits, B6 or B7 is set.
- (2) This bit is a *polarity independent* 'software' copy of the $\overline{\text{EVENT}}$ pin, i.e. it is under the control of B3.
- (3) Writing a '1' to this bit clears an event condition in Interrupt mode, but has no effect in comparator mode. When read, this bit always returns 0. Once the measured temperature exceeds the critical limit, setting this bit has no effect (see Figure 5).
- (4) Cleared at power-on reset (POR). Once set, this bit can only be cleared by a POR condition.
- (5) The TS powers up into active mode, i.e. this bit is cleared at power-on reset (POR). When the TS is shut down the ADC is disabled and the temperature reading is frozen to the most recently recorded value. The TS can not be shut down (B8 can not be set) as long as either one of the two lock bits, B6 or B7 is set. However, the bit can be cleared at any time.
- (6) The EVENT output is "open-drain" and requires an external pull-up resistor for either polarity. The "natural" polarity is "active low", as it allows "wired-or" operation on the EVENT bus.
- (7) Can not be set as long as lock bit B6 is set.

HIGH LIMIT REGISTER

B15	B14	B13	B12	B11	B10	B9	B8
0	0	0	Sign	128°C	64°C	32°C	16°C
B7	B6	B5	B4	B3	B2	B1	B0
8°C	4°C	2°C	1°C	0.5°C	0.25°C	0	0

LOW LIMIT REGISTER

B15	B14	B13	B12	B11	B10	B9	B8
0	0	0	Sign	128°C	64°C	32°C	16°C
B7	B6	B5	B4	B3	B2	B1	B0
8°C	4°C	2°C	1°C	0.5°C	0.25°C	0	0

TCRIT LIMIT REGISTER

B15	B14	B13	B12	B11	B10	B9	B8
0	0	0	Sign	128°C	64°C	32°C	16°C
B7	B6	B5	B4	B3	B2	B1	B0
8°C	4°C	2°C	1°C	0.5°C	0.25°C	0	0

TEMPERATURE DATA REGISTER

B15	B14	B13	B12	B11	B10	B9	B8
TCRIT	HIGH	LOW	Sign	128°C	64°C	32°C	16°C
B7	B6	B5	B4	B3	B2	B1	B0
8°C	4°C	2°C	1°C	0.5°C	0.25°C*	0.125°C*	0.0625°C*
* When applicable (as defined by Capability bit TRES), unsupported bits will read as 0							

Bit	Description
B15	0: Temperature is below the TCRIT limit 1: Temperature is equal to or above the TCRIT limit
B14	0: Temperature is equal to or below the High limit 1: Temperature is above the High limit
B13	0: Temperature is equal to or above the Low limit 1: Temperature is below the Low limit

REGISTER DATA FORMAT

The values used in the temperature data register and the 3 temperature trip point registers are expressed in two's complement format. The measured temperature value is expressed with 12-bit resolution, while the 3 trip temperature limits are set with 10-bit resolution. The total temperature range is arbitrarily defined as 256°C, thus yielding an LSB of 0.0625°C for the measured temperature and 0.25°C for the 3 limit values. Bit B12 in all temperature registers represents the sign, with a '0' indicating a positive, and a '1' a negative value. In two's complement format, negative values are obtained by complementing their positive counterpart and adding a '1', so that the sum of opposite signed numbers, but of equal absolute value, adds up to zero.

Note that trailing '0' bits, are '0' irrespective of polarity. Therefore the don't care bits (B1 and B0) in the 10-bit resolution temperature limit registers, are always '0'.

12-Bit Temperature Data Format

Binary (B12 to B0)	Hex	Temperature
1 1100 1001 0000	1C90	-55°C
1 1100 1110 0000	1CE0	-50°C
1 1110 0111 0000	1E70	-25°C
1 1111 1111 1111	1FFF	-0.0625°C
0 0000 0000 0000	000	0°C
0 0000 0000 0001	001	+0.0625°C
0 0001 1001 0000	190	+25°C
0 0011 0010 0000	320	+50°C
0 0111 1101 0000	7D0	+125°C

EVENT PIN FUNCTIONALITY

The $\overline{\text{EVENT}}$ output reacts to temperature changes as illustrated in Figure 14, and according to the operating mode defined by the Configuration register.

In **Interrupt Mode**, the enabled $\overline{\text{EVENT}}$ output will be asserted every time the temperature crosses one of the alarm window limits, and can be de-asserted by writing a '1' to the clear event bit (B5) in the configuration register. When the temperature exceeds the critical limit, the event remains asserted as long as the temperature stays above the critical limit and can not be cleared.

In **Comparator Mode**, the $\overline{\text{EVENT}}$ output is asserted outside the alarm window limits, while in **Critical Temperature Mode**, $\overline{\text{EVENT}}$ is asserted only above the critical limit. The exact trip limits are determined by the 3 temperature limit settings and the hysteresis offsets, as illustrated in Figure 15.

Following a TS shut-down request, the converter is stopped and the most recently recorded temperature value present in the TDR is frozen; the $\overline{\text{EVENT}}$ output will continue to reflect the state immediately preceding the shut-down command. Therefore, if the state of the $\overline{\text{EVENT}}$ output creates an undesirable bus condition, appropriate action must be taken either before or after shutting down the TS. This may require clearing the event, disabling the $\overline{\text{EVENT}}$ output or perhaps changing the $\overline{\text{EVENT}}$ output polarity.

In normal use, events are triggered by a change in recorded temperature, but the CAT34TS02 will also respond to limit register changes. Whereas recorded temperature values are updated at sampling rate frequency, limits can be modified at any time. The enabled $\overline{\text{EVENT}}$ output will react to limit changes as soon as the respective registers are updated. This feature may be useful during testing.

Figure 14. Event Detail

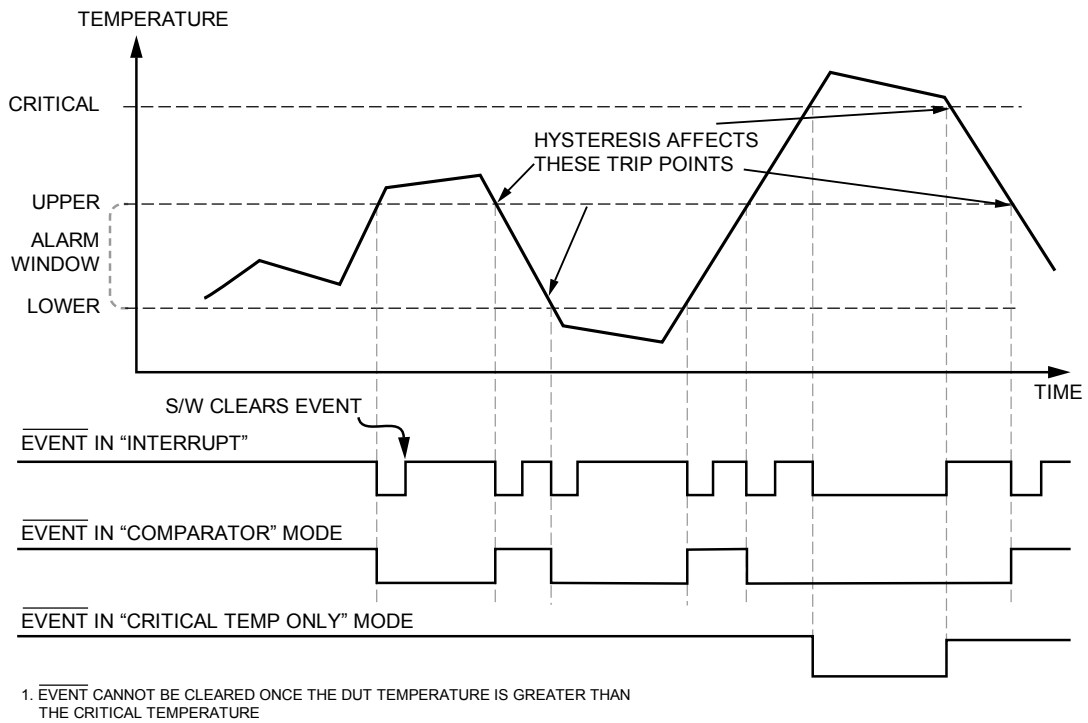
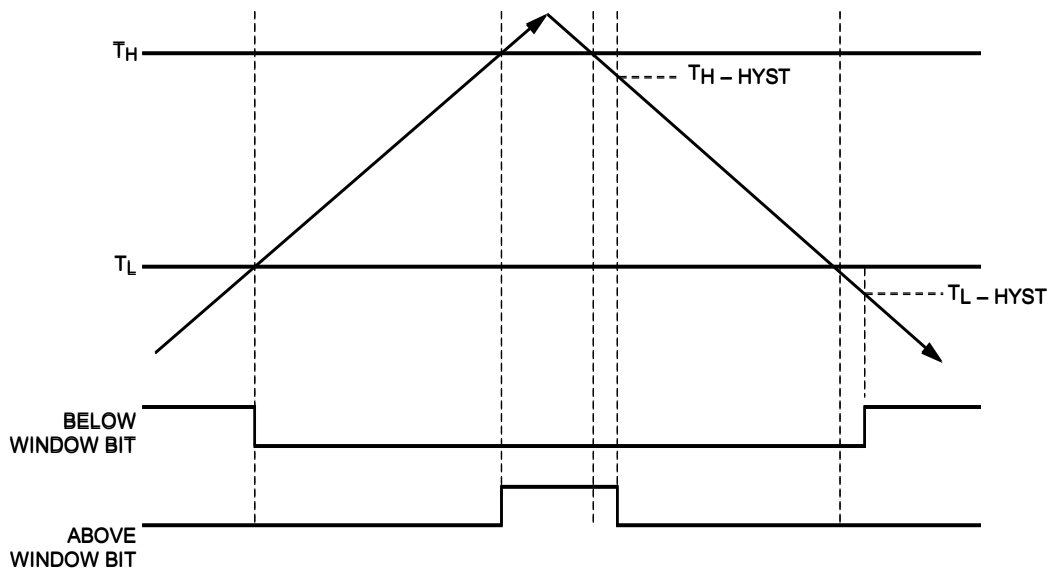
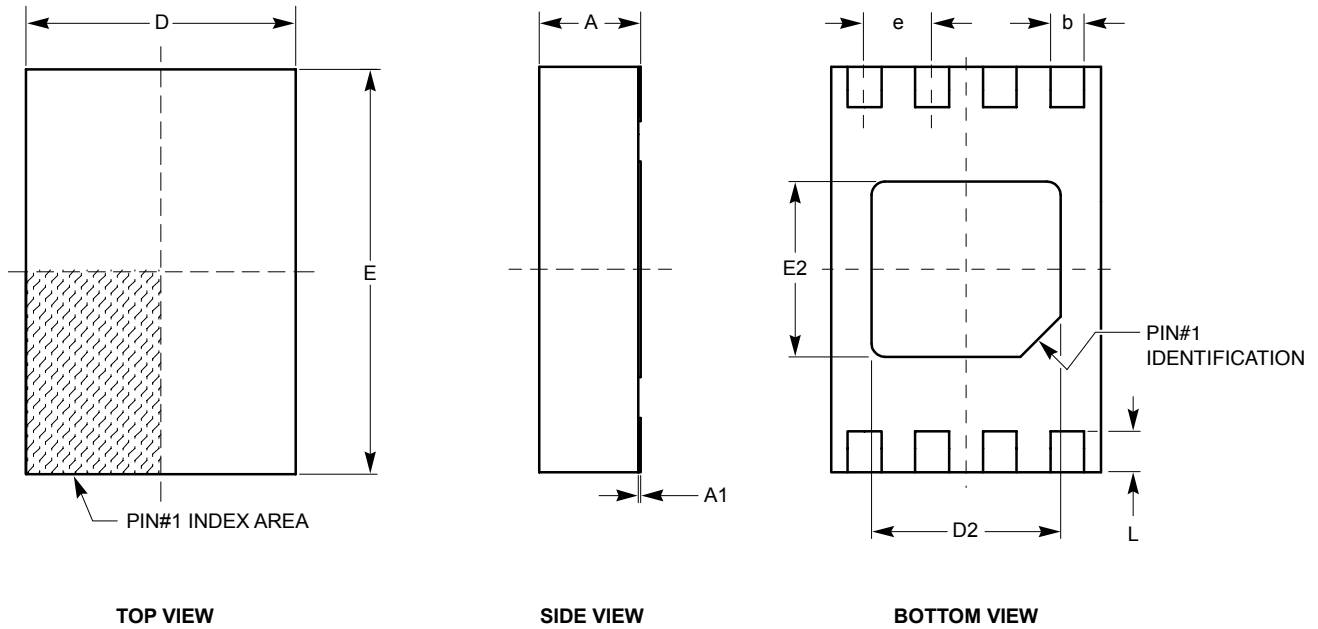

Figure 15. Hysteresis Detail



PACKAGE OUTLINE DRAWING

TDFN 8-Pad 2 x 3 mm (VP2)



SYMBOL	MIN	NOM	MAX
A	0.70	0.75	0.80
A1	0.00	0.02	0.05
A2	0.45	0.55	0.65
A3	0.20 REF		
b	0.20	0.25	0.30
D	1.90	2.00	2.10
D2	1.30	1.40	1.50
E	2.90	3.00	3.10
E2	1.20	1.30	1.40
e	050 TYP		
L	0.20	0.30	0.40

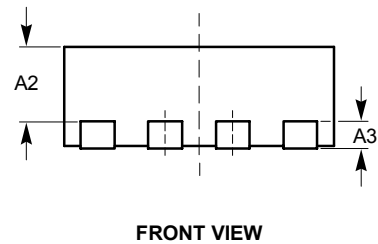

Notes:

- (1) All dimensions are in millimeters.
- (2) Complies with JEDEC specification MO-229.

EXAMPLE OF ORDERING INFORMATION

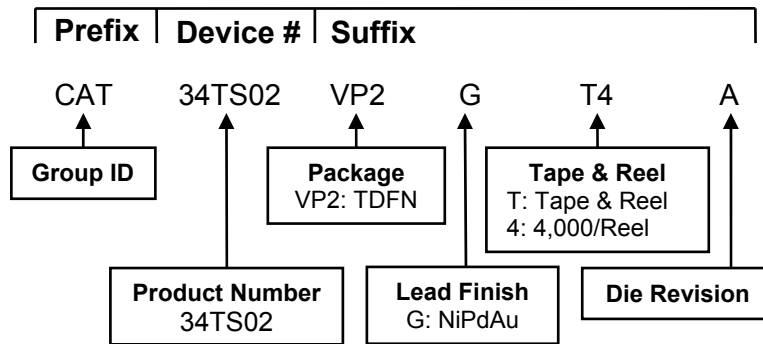

TOP MARKING

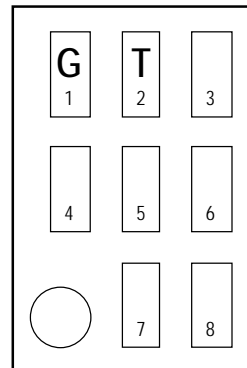

Top Mark Legend (Position)

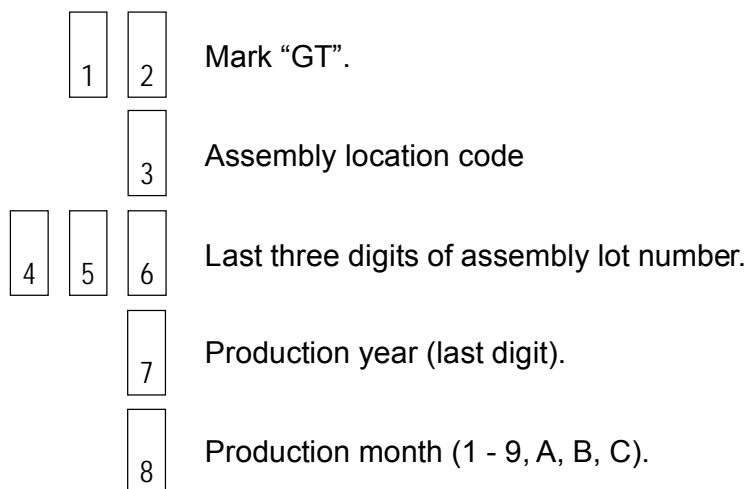

Notes:

- (1) All packages are RoHS-compliant (Lead-free, Halogen-free).
- (2) The standard lead finish is NiPdAu.
- (3) This device used in the above example is a CAT34TS02VP2GT4A in TDFN, NiPdAu Lead Frame, Tape & Reel, 4,000/Reel.

REVISION HISTORY

Date	Revision	Description
06-Aug-08	A	Initial Issue
15-Aug-08	B	Update Power-On Reset, Temperature Sensor Operation and Register
04-Nov-08	C	Change logo and fine print to ON Semiconductor
20-Apr-09	D	Update Features, Description, Parametric Tables, TS functionality description, Ordering Information, Align to JC42.4 TSE2002av Standard terminology
21-Jul-09	E	Updated Features Updated Parametric tables (D.C. and A.C.) Updated Bus Timing figure Added Typical Performance Characteristics Updated Capability Register content Updated Configuration Register description Updated Ordering Information
2-Sep-09	F	Updated A.C. Characteristics table and notes Updated Capability Register description and notes

ON Semiconductor and  are registered trademarks of Semiconductor Components Industries, LLC (SCILLC). SCILLC reserves the right to make changes without further notice to any products herein. SCILLC makes no warranty, representation or guarantee regarding the suitability of its products for any particular purpose, nor does SCILLC assume any liability arising out of the application or use of any product or circuit, and specifically disclaims any and all liability, including without limitation special, consequential or incidental damages. "Typical" parameters which may be provided in SCILLC data sheets and/or specifications can and do vary in different applications and actual performance may vary over time. All operating parameters, including "Typicals" must be validated for each customer application by customer's technical experts. SCILLC does not convey any license under its patent rights nor the rights of others. SCILLC products are not designed, intended, or authorized for use as components in systems intended for surgical implant into the body, or other applications intended to support or sustain life, or for any other application in which the failure of the SCILLC product could create a situation where personal injury or death may occur. Should Buyer purchase or use SCILLC products for any such unintended or unauthorized application, Buyer shall indemnify and hold SCILLC and its officers, employees, subsidiaries, affiliates, and distributors harmless against all claims, costs, damages, and expenses, and reasonable attorney fees arising out of, directly or indirectly, any claim of personal injury or death associated with such unintended or unauthorized use, even if such claim alleges that SCILLC was negligent regarding the design or manufacture of the part. SCILLC is an Equal Opportunity/Affirmative Action Employer. This literature is subject to all applicable copyright laws and is not for resale in any manner.

PUBLICATION ORDERING INFORMATION

LITERATURE FULFILLMENT:

Literature Distribution Center for ON Semiconductor
P.O. Box 5163, Denver, Colorado 80217 USA
Phone: 303-675-2175 or 800-344-3860 Toll Free USA/Canada
Fax: 303-675-2176 or 800-344-3867 Toll Free USA/Canada
Email: orderlit@onsemi.com

N. American Technical Support: 800-282-9855 Toll Free
USA/Canada
Europe, Middle East and Africa Technical Support:
Phone: 421 33 790 2910
Japan Customer Focus Center:
Phone: 81-3-5773-3850

ON Semiconductor Website: www.onsemi.com

Order Literature: <http://www.onsemi.com/orderlit>

For additional information, please contact your local Sales Representative